

NUMERICAL SIMULATION OF FLOWS IN AN ENGINE CYLINDER WITH AN
ECCENTRIC DEEP BOWL COMBUSTION CHAMBER DURING COMPRESSION

(2nd Report: NUMERICAL EXAMPLE)

محاكاة عددية للسريان داخل اسطوانة ذات غرفة احتراق غير مركزية في المكبس
خلال شوط الانضغاط * (التقرير الثاني : مثال عددي)

By

M.S. El Kady1, H.J.Mascheck2 and A.Hoche3

الخلاصة - في هذا البحث تم استخدام النموذج العددي الذي يصيغ حركة المسوا^ا
الدوامية الغير مستقرة ثلاثية الأبعاد داخل اسطوانة محرك ترددي والذي تم تقديمه
في التقرير الأول (١) وذلك لحساب واستنباط ديناميكية الهواء في غرفة احتراق
غير مركزية لاسطوانة ماكينة ديزل ذات حقن مباشر ، وتم التركيز على حساب التوزيع
العددي والفراغي لمتجهات السرعة وخطوط الانسياب الثابتة للضغط والسرعة وكذلك
تم التركيز على شدة الدوران ومراكزه داخل الاسطوانة . وعلى الرغم من أن العديد
من خصائص المائع الاضطرابي داخل اسطوانة المحرك لم يتم التعرف عليها حتى
الآن إلا أن هذا المثال قد أسهم في تقدم ملحوظ في فهم حركة المائع داخل الاسطوانة
خلال شوط الانضغاط وبالأخص قرب النقطة الميتة العليا .

ABSTRACT

In this paper the numerical model that calculates the fluid dynamics in an engine cylinder which is represented in the first part of this paper [1] is used to simulate the compression stroke. The calculated results are presented for a cupped piston geometry under operating conditions typically of those contemplated for direct injection diesel engine. Particular emphasis is placed on the spatial and temporal distribution of the flow, velocity vectors and contour lines, swirl intensity and swirl centers. Although many of the detailed features of the turbulent flow are still unresolved, some progress of the understanding of the in-cylinder flow specially near the top of the dead center (TDC) is gained.

1. Faculty of Engineering El Mansoura University
2. Professor, Institute of Fluid Mechanics, Technical University of Dresden, Dresden, Germany (GDR)
3. Professor and head of the Institute of I.C.E., Technical University of Dresden, Dresden, Germany (GDR)

1. INTRODUCTION

Understanding the in-cylinder fluid mechanics is a necessary step in predicting the performance of the reciprocating engine. The combustion rate, stratification and fuel-air mixing, formation of pollutants are highly dependent in the flow field that exists in the engine cylinder specially in the latest region of the compression process. Although the mean flows and turbulence characteristics have been measured for conventional and diesel engines by many investigators [2-4] detailed features of the turbulent flow and combustion are still unresolved. Analytical technique is now available for predicting the flow in the engine cylinder. It is shown and described in the first part of this paper [1] and can be used as interpretive tool. In this paper, the analytical technique is used to predict the flow field in an eccentric bowl combustion chamber of a small diesel engine cylinder during the compression stroke. Our goal of this is to increase our insight into this process that controls the combustion and pollutant formation and to increase our understanding to the in-cylinder fluid mechanics and the characterization of the turbulent field near top center of the compression process.

2. COMPUTED EXAMPLE

All computations were performed with a small size direct injection diesel engine having a cylinder diameter of 120 mm, a stroke of 12.8 mm, a length ratio of connecting rod to crank arm 3.3. The base line conditions are as follows; the piston head clearance at the top dead center 7.2 mm, diametral ratio of bowl to piston d/D 0.4, the depth of the bowl is 37.5 mm, the eccentricity of the bowl axis is 10.5 mm and the engine speed is 2400 rpm.

During the computation it is assumed that when the inlet valve closes the air in the cylinder has a forced vortex motion with constant swirl and rotation. The swirl ratio (ratio of swirl angular velocity of that of the engine shaft) is 0.6. The piston velocity is still small compared to the sonic speed in the flow, therefore, the density is assumed to be spatially uniform but time dependent, and the flow is assumed to be modeled via a large inviscid core plus a very small viscous boundary layer at the walls.

3. RESULTS AND DISCUSSION

Figures 1 and 2 represent the velocity vectors and the velocity contours in the symmetrical plane A-A which is shown in Fig. 3, for the last 60 CA before TDC 120, 150, 160, 170 and 180 after BDC. It is shown in figures 1 and 2 that as the piston goes up the air is pushed into the bowl forming the radial inward squish jet. The squish jet has a different radial velocities along the bowl top because of the eccentricity of the bowl and the unequal shoulder of the piston crown. The maximum radial velocity occurs always at the greater side by the point b while the minimum velocity occurs at the smallest side at c. Points b

and c are shown in Fig. 3 which represents the different sections in the cylinder.

It is also shown that the eccentricity of the bowl creates higher radial squish velocity than it in the axisymmetric case which is described in [5]. The maximum squish radial velocity which occurs at point b occurs also by nearly 155-160 CA after BDC that is nearly 20-25 CA before TDC. The increase of this maximum squish by eccentricity ratio (eccentricity to cylinder radius) of 0.175 is about 35% over the maximum squish radial velocity by the axisymmetric bowl.

In the earlier stages of the flow the air jet is bent at the corners of the bowl. However, once a small anti-clockwise vortex is formed at the entrance of the bowl at the greater side the air jet diverts at the upper part of the bowl thereby the anti-clockwise vortex becomes greater and greater as the crank angle proceeds until it exists in the whole cavity and forms a toroidal motion in the cavity at the compression end.

The velocity variation at the bowl wall changes as the piston moves upward. At the bowl right side wall where the fuel is expected to be injected, the velocity varies from 0 to 2.7 m/s at 120 CA after BDC. then the variation of the velocity increases as the crank angle proceeds until 160 CA after BDC where it varies from 0 to 16.8 m/s. After this condition it begins to decrease with the proceeding of the crank angle. Therefore, it is better in this case to inject the fuel nearly at 160 CA after BDC.

Figure 4 shows the constant lines of the relative pressure $\Delta P = P - P_0$ (where P_0 is the mean pressure in the cylinder during the showed crank angle) for the symmetrical section A-A for the crank angles 120 after BDC to the TDC during compression. The highest pressure regions are near the cylinder middle. The pressure in the bowl decreases towards the bottom and there is also a minimum pressure region at the bowl right side near the top. At the end of compression process and the beginning of the expansion at the TDC the flow begins to change its characteristics; the highest pressure is now at the bowl bottom and it decreases in the direction of the cylinder top.

Figures 5 and 6 show the vector and constant lines of the velocity in the planes $z = \text{constant}$ where $k = 2, 4, 5, 9, 13$ and 17 for the crank angle 170 after BDC and TDC. A strong swirl is generated in the plane $z = \text{const.}$, the swirl center exists considerably away from the symmetrical plane A-A and the cylinder axis. It is located with the increase of z helically around the cylinder axis. The swirl intensity increases in the cylinder space with the increase of z and it tends to reach its maximum value at the piston crown where $k=5$, then it decreases again in the piston bowl till its minimum value near the piston bottom. As shown in Figure 6 the maximum velocity in the z plane increases as z increases till it reaches its maximum value at the piston crown where $k=5$ and then it decreases in the piston cavity and it tends to reach its minimum value near the piston bottom where $k=17$. The points of the maximum velocities are located helically with the proceeding of z around the bowl axis and make

a spiral form. In the z planes where $k=2$ and 4 in the cylinder space the radial velocities are very small near the cylinder wall and the flow is therefore nearly in the azimuthal direction, but due to the squish flow which exists at the circumference of the bowl top the radial velocity component becomes higher and the flow is turned towards the middle of the bowl center.

Fig. 7 shows the constant lines of the relative pressure for the different sections of z and $k=2, 4, 9, 13,$ and 17 at the TDC. Since the strong swirl which is generated in the planes $z=\text{constant}$ as shown in Figures 5 and 6 the pressure becomes much lower near the bowl axis in both the cylinder and the bowl and the swirl center has always the minimum pressure value. The pressure increases from the right to the left in the cylinder space $k=2, 4$ with a minimum value near the center of the bowl and it decreases from outside to inside in the deep bowl at $k=9, 13$ and 17 .

Figures 8 and 9 give the vector and constant lines of the velocity for the crank angles 150 after BDC to the TDC at the same section with $k=9$ which is nearly located at the third of the bowl height. At the moment where the inlet valve closes during the compression stroke the flow is assumed to have constant swirl. With the proceeding of the crank angle the swirl velocity increases and until 150 CA the flow is still like a rigid body rotation. After 150 the flow is no longer like the rigid body rotation and a region of maximum velocity begins to be formed at one side of the section. This maximum velocity increases with the proceeding of the crank angle and reaches its maximum value at the end of the compression. The maximum velocity and also the swirl center exist nearly at the same positions away from the bowl center with the proceeding of the crank angle.

Another figures and discussion for the flow characteristics for this computed example can be found in [6].

4. CONCLUSION

A numerical simulating algorithm is used to discuss the qualitative behaviour of the compression process. Our understanding of this process is based on the global observations of the computed flow field of an example. Although many of the detailed features of the turbulent flow are still unresolved, this example gives some progress in understanding the global features of the behaviour of the in-cylinder flow field specially near the TDC. The development of the swirl flow, the positions of the swirl centers, the positions of the maximum velocities, the velocity variation, the pressure difference and the formation and development of the vortices in the bowl are now better understood.

5. REFERENCES

1. El Kady, M.S., Mascheck, H.J., Hoche A., "Numerical simulation of flows in an engine cylinder with an eccentric deep bowl combustion chamber during compression (1st Report: Formulation and algorithm) MEJ, Vol. 16, No. 2, Dec. 1989
2. Lancaster, D.R., "Effects of engine variables on turbulence in spark ignition engine" SAE paper no 760159, 1976.
3. Matsuka, S., Nagakura, K., Kimamoto, T. and Aoyagi, Y., "Application of laser doppler anemometry to a motored diesel engine" SAE paper no 800965, 1980.
4. Rask, R.B., "Laser doppler measurements in an internal combustion engines", SAE paper no. 790094, 1979.
5. El Kady, M.S., Mascheck, H.J., Hoche, A. " Numerical simulation of the flow in a symmetrical deep bowl combustion chamber of a diesel engine cylinder during the compression stroke" MEJ, Vol 12, No. 2 Dec. 1987, pp M20-M30.
6. El Kady, M.S., "Berechnung symmetrischer und unsymmetrischer Zylinder-Brennraum-Stroemungen in Dieselmotoren beim Verdichtungshub", Dissertation, TU Dresden March 1985.

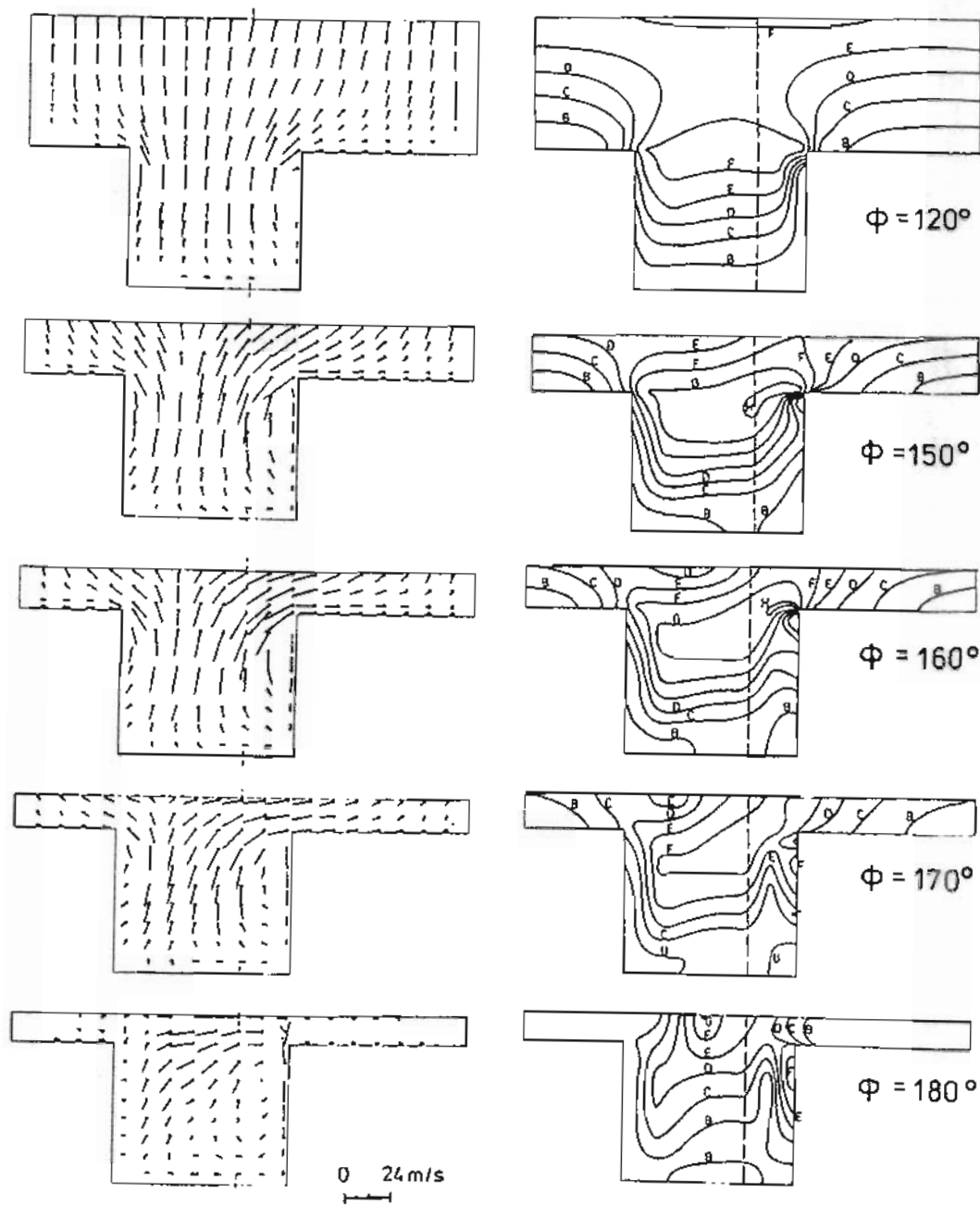

Fig. 1 Velocity vectors in the symmetrical plane A-A

Fig. 2 Velocity contours in the symmetrical plane A-A
 B=2.4, C=4.8, D=7.2,
 E=9.6, F=12, G=14.4,
 H=16.8 m/s

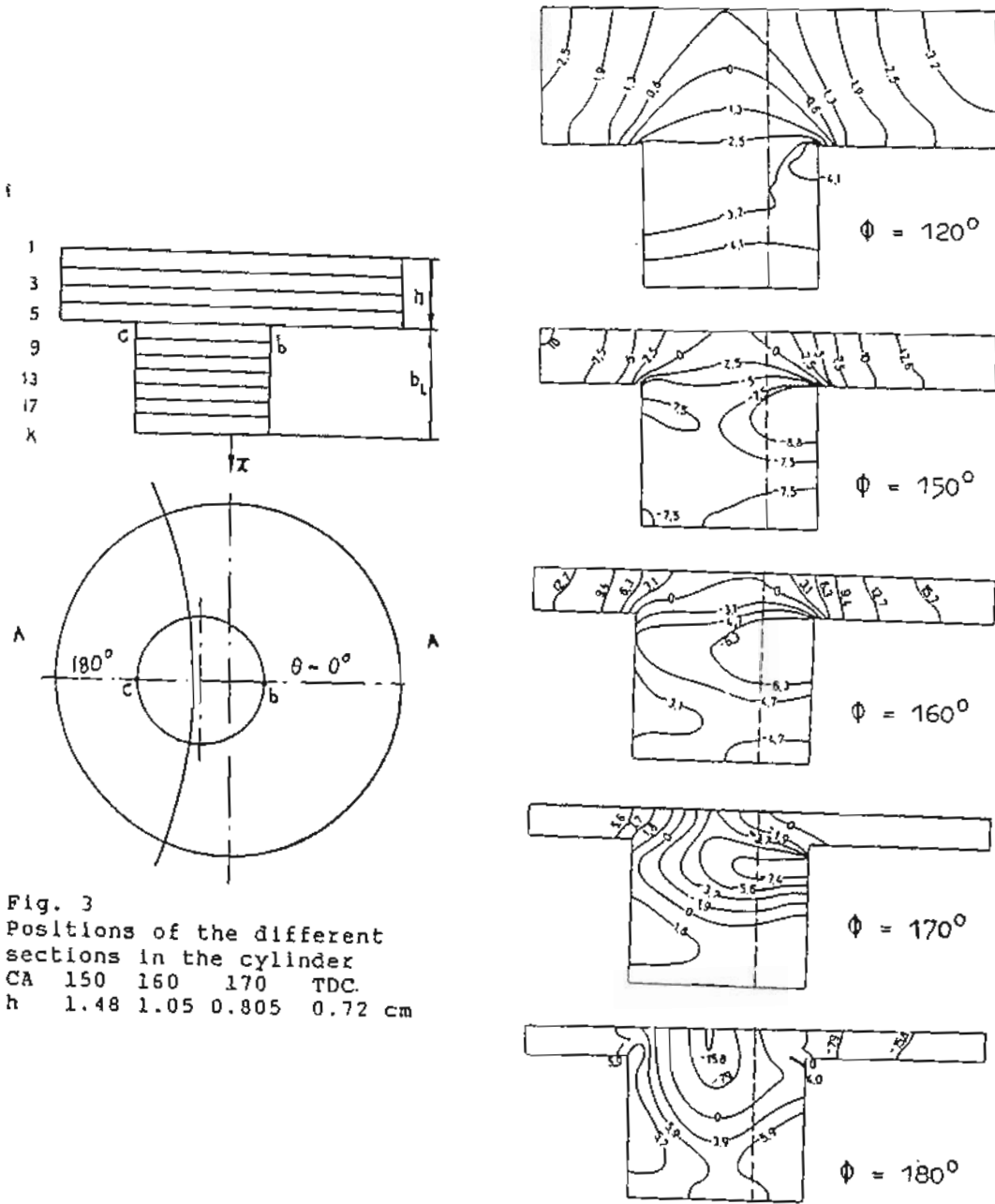

Fig. 3
Positions of the different sections in the cylinder
CA 150 160 170 TDC.
h 1.48 1.05 0.805 0.72 cm

Fig. 4
The constant relative pressure lines for the symmetrical plane for 120 CA after BDC to TDC during compression

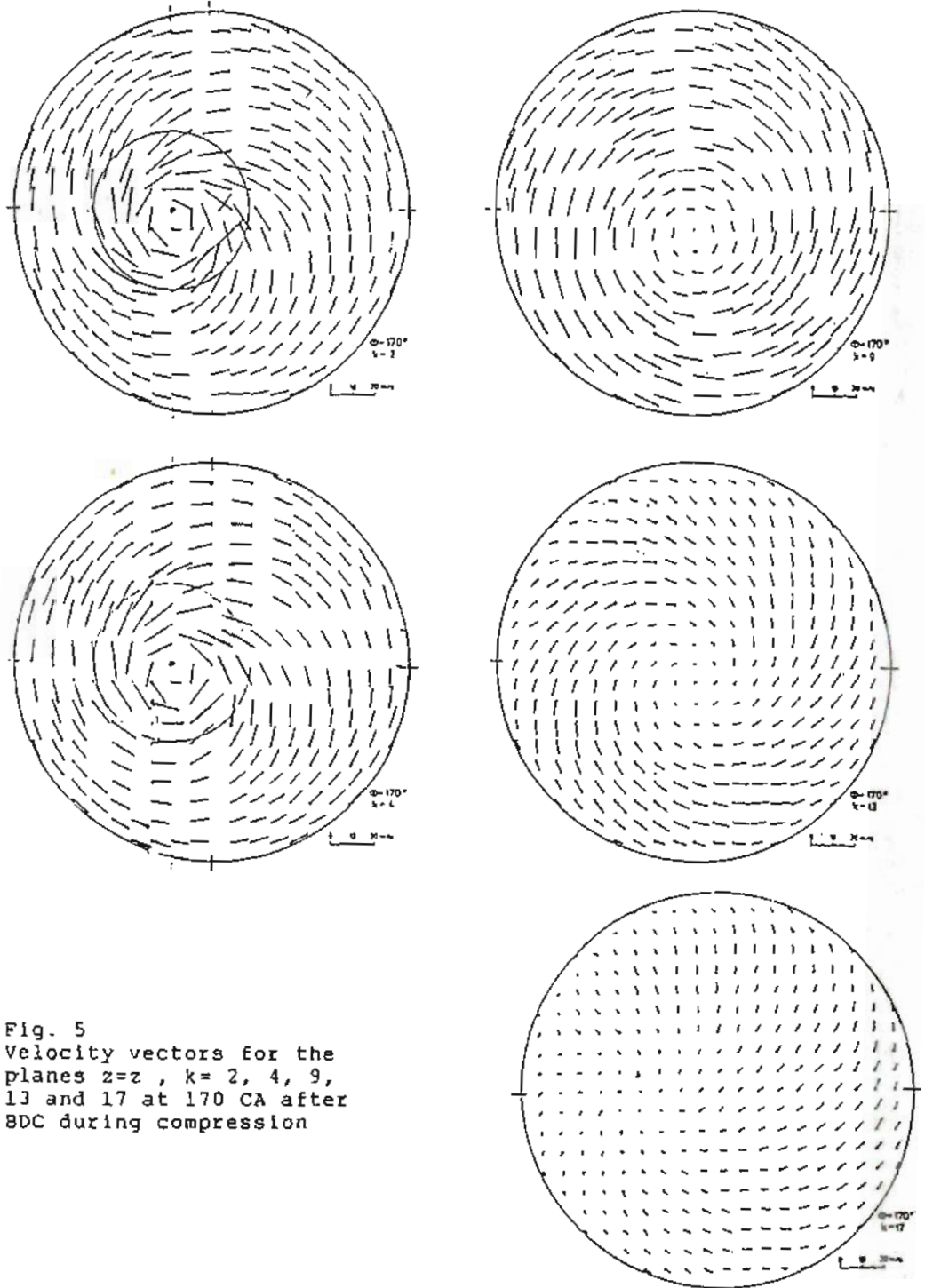

Fig. 5
Velocity vectors for the
planes $z=z$, $k=2, 4, 9,$
 13 and 17 at 170 CA after
BDC during compression

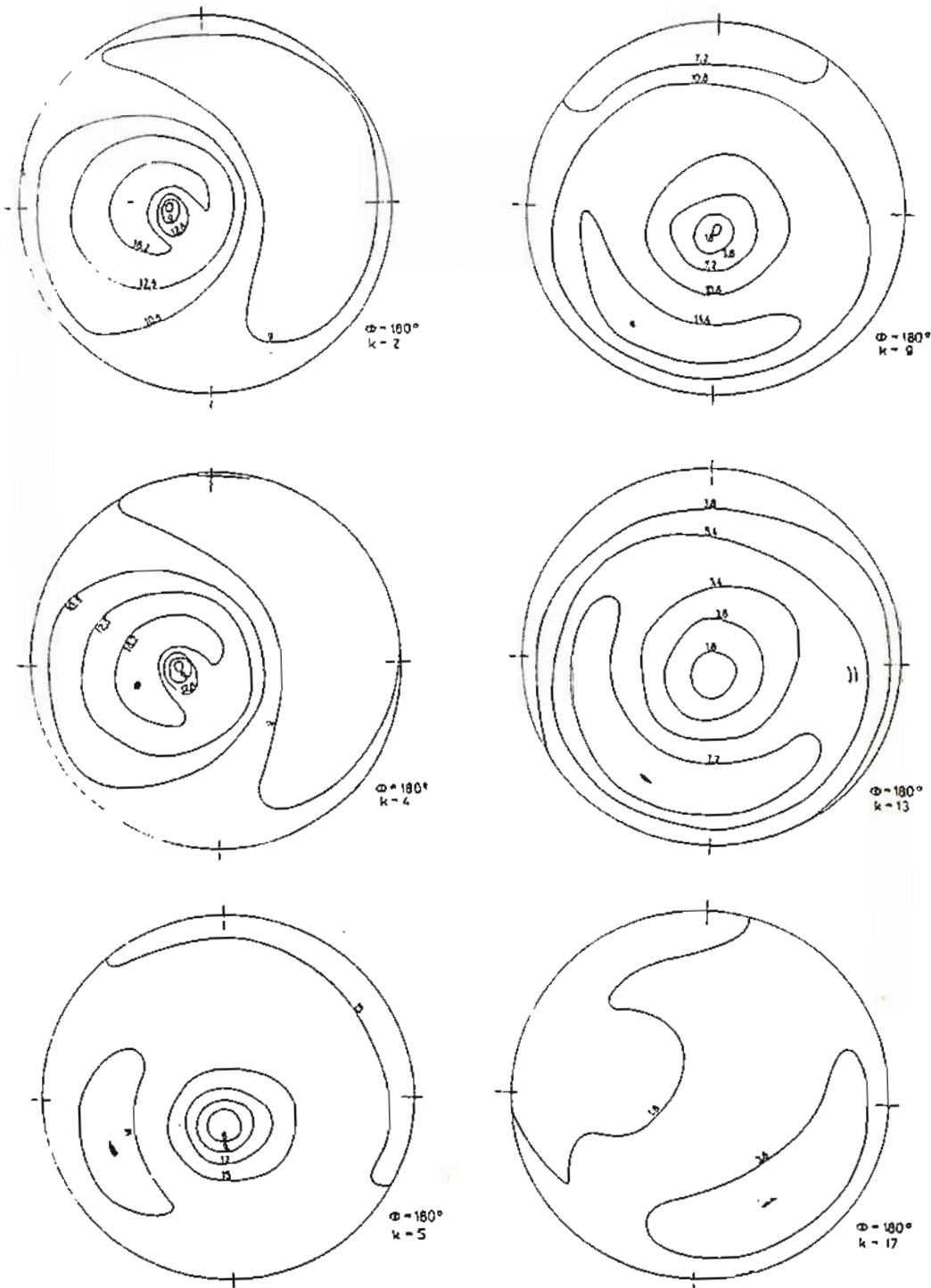

Fig. 6
 Velocity contours in the planes $z=z$ and $k=2, 4$ in the cylinder space and $k=5, 9, 13$ and 17 in the deep bowl for the TDC at the end of compression process.

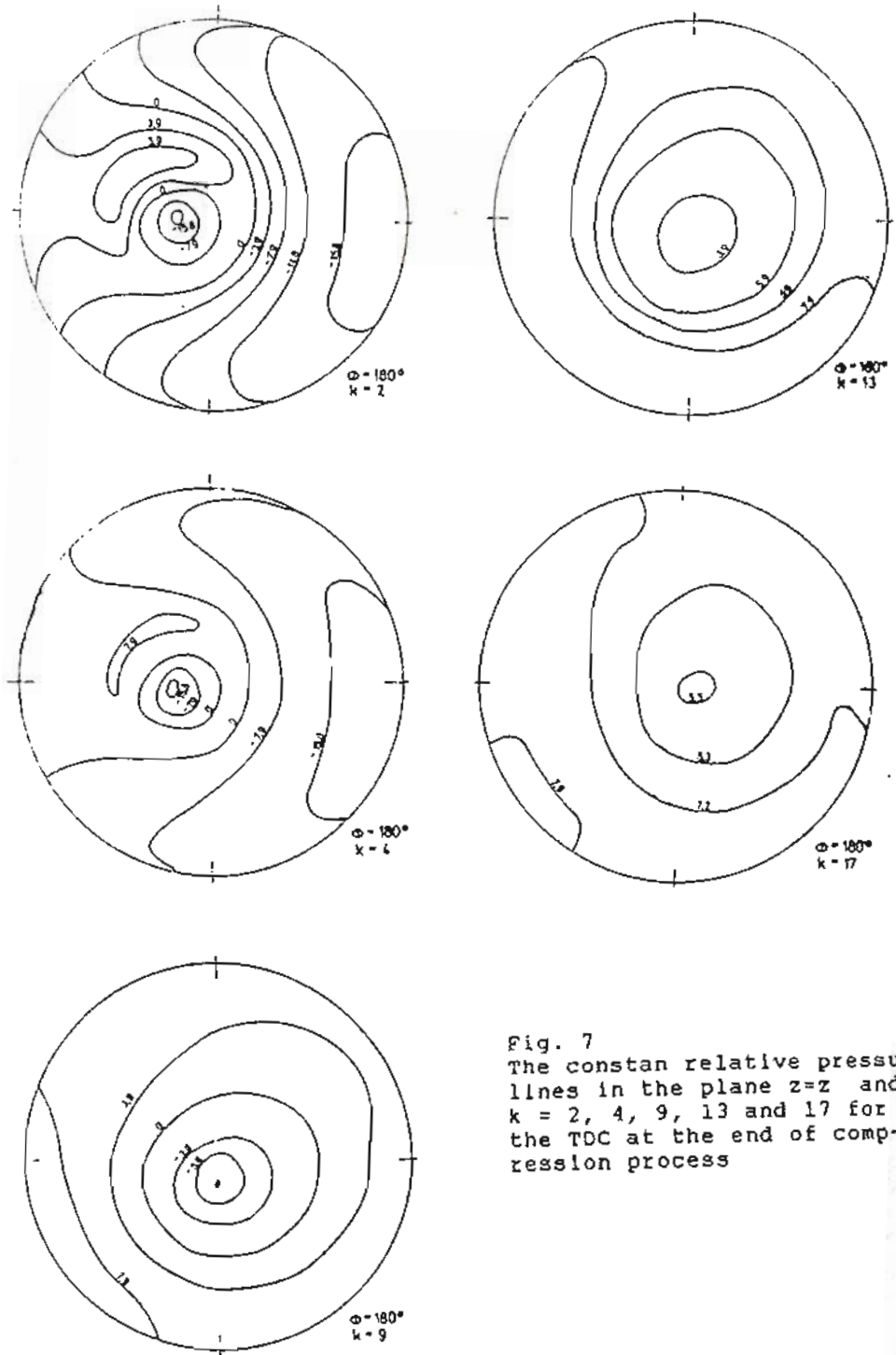

Fig. 7
The constan relative pressure
lines in the plane $z=z$ and
 $k = 2, 4, 9, 13$ and 17
for the TDC at the end of comp-
ression process

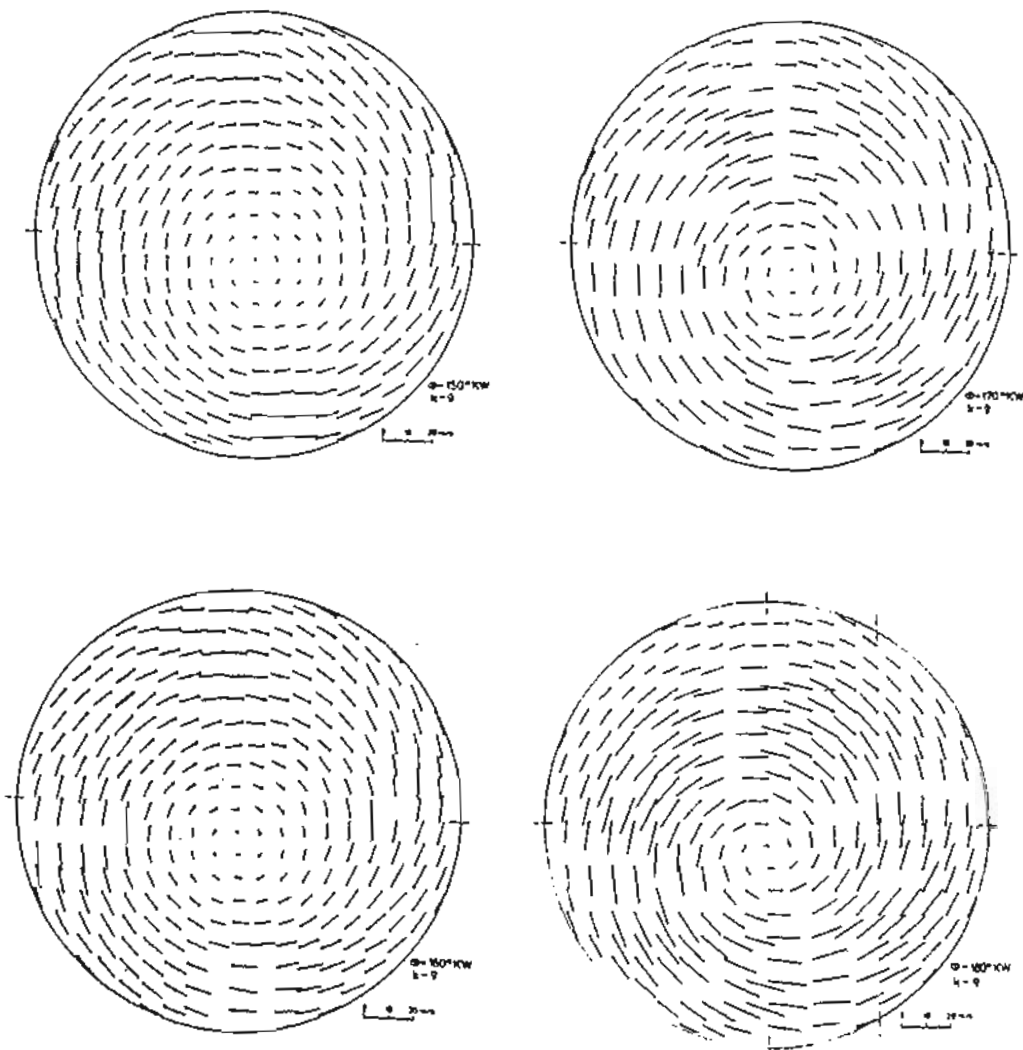

Fig. 8
Velocity vectors in the plane $z=z$ and $k=9$ which is nearly located at one third of the bowl height for different crank angles from 150° after BDC to the end of compression process

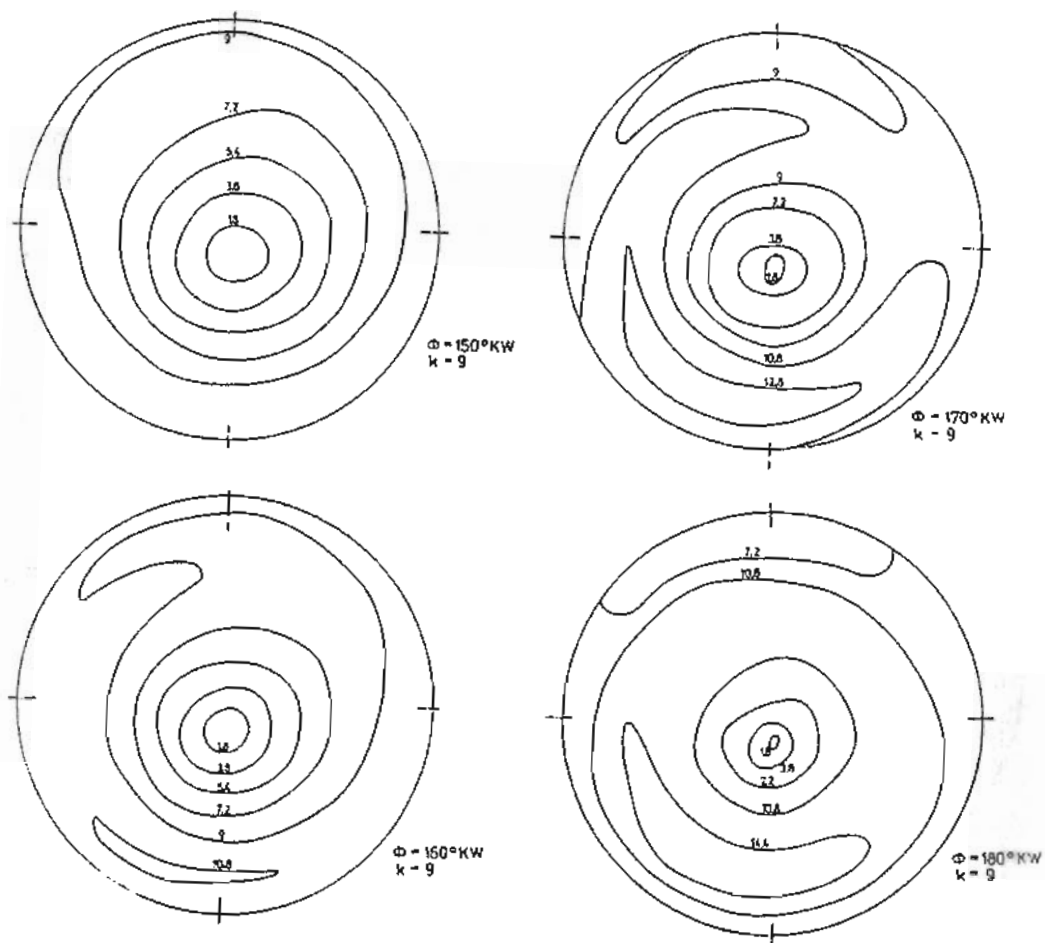

Fig. 9 Velocity contours in the z-plane $k=9$ which is nearly located at one third of the bowl height for different crank angles