

Convection Heat Transfer and Friction Factor of Al_2O_3 /Water Nanofluid Flows inside Circular Tube with Inserting Helical Tape

"إنتقال الحرارة بالحمل ومعامل الإحتكاك لمائع مكون من الماء وجزيئات فائقة الدقة من أكسيد الألمونيوم يمر داخل أنبوب دائري بداخله شريط حلزوني"

Hesham M. Mostafa * and M. G. Mousa **

* Mechanical Eng. Dept., Higher Technological Institute, Tenth of Ramadan City, Egypt.

** Mechanical Power Eng. Dept., Faculty of Engineering, Mansoura Univ., Man., Egypt.

Email: DrHeshamMostafa@Yahoo.com & Mgmousa@mans.edu.eg

خلاصة البحث:

في هذا البحث أجريت دراسة معملية لإنتقال الحرارة بالحمل الجبري ومعامل الإحتكاك لمائع مكون من الماء وجزيئات فائقة الدقة من أكسيد الألمونيوم يمر داخل أنبوب دائري مع إنراج شريط حلزوني من الداخل. الأنبوب مسخن بواسطة ملف كهربى ملفوف حول الأنبوب من الخارج وذلك حتى يعطى فيض حرارى ثابت عند السطح. تم تغيير تركيز الجزيئات الفائقة الدقة من أكسيد الألمونيوم في مائع التشغيل حتى 2%. وإتمام هذا الغرض تم تصميم وتنفيذ دائرة إختبار معملية لمقارنة كمية الحرارة المنتقلة والإنخفاض فى الضغط لمائع التشغيل المار بالأنبوب المدرج به شريط حلزوني من الداخل مقارنة بالأنبوب الأملس (الخالى من الشريط الحلزوني) وذلك عند معدلات تدفق مختلفة للمائع الذى يمر داخل الأنبوب مع تغيير الفيض الحرارى. وقد تم تزويد دائرة الإختبار بأبزة القياس المطلوبة لقياس كل من درجات الحرارة والتدفق والفولت والإنخفاض فى الضغط. حيث أجريت التجارب عند قيم مختلفة لرقم رينولدز من 600 حتى 2500 والفيض الحرارى من 3000 حتى 6000 وات/م². وقد تمت دراسة تأثير تغيير ظروف التشغيل هذه على كمية الحرارة المنتقلة والإنخفاض فى الضغط وبالتالي تم حساب معامل إنتقال الحرارة بالحمل الجبرى وكذلك معامل الإحتكاك لسريان المائع المار داخل الأنبوب.

وقد أظهرت النتائج المعملية أن درجة حرارة سطح الأنبوب تقل مع إستخدام مائع التشغيل حتى تركيز 0.8% بعدها ترتفع درجة حرارة السطح. وبالتالي فإن معامل إنتقال الحرارة بالحمل الجبرى يأخذ أعلى قيمة له عند هذا التركيز. معامل إنتقال الحرارة بالحمل الجبرى وكذلك الإنخفاض فى الضغط يزداد مع زيادة رقم رينولدز وذلك لكل من الأنبوب التى بها شريط حلزوني من الداخل والأنبوب الأملس (الخالى من الشريط الحلزوني). القيمة المتوسطة لمعامل الأداء الحرارى والهيدرولى لمائع التشغيل المكون من الماء وجزيئات فائقة الدقة كانت حوالى 1.8 وللماء فقط كانت حوالى 1.4. وقد تمت مقارنة النتائج المعملية التى تم الحصول عليها مع نتائج الأبحاث السابقة حيث كانت نتيجة المقارنة مرضية.

Abstract

Forced convection heat transfer and friction factor for nanofluid flows inside circular horizontal tube with and without inserting helical tape, was experimentally studied. Electric heater was wrapped around the outer surface of the tube to obtain a constant and uniform heat flux at the tube wall. Experiments are conducted with adding nano-particles (Al_2O_3) to water up to 2% by volume to obtain different concentrations of nanofluids. An experimental test loop equipped with the required measuring instruments was designed and constructed to assess the effects of nano-particles concentration, mass flow rate, and applied heat flux on the convection heat transfer process and pressure drop. The tested tube fitted with screw helical tape inserts to evaluate its effects on heat transfer rate and friction factor with nanofluid as the working fluid compared with pure water. The measurements of temperature, flow rate, applied volt and pressure drop are recorded and manipulated to calculate the convection heat transfer coefficient and friction factor.

The obtained experimental results show that, wall temperature was reduced by using nanofluid compared with pure water. Accordingly, the convection heat transfer coefficient increased when using nanofluid and increased also with increasing heat flux and mass flow rate (Reynolds number). Higher rates of heat transfer and pressure drop are obtained from the tube fitted with screw helical tape insert compared to flow in a plain tube under similar conditions. This improvement in the convection heat transfer coefficient characterized by a

swirling flow as a result of the secondary flow of the fluid flow inside tube with helical tape. The average value for the thermal-hydraulic performance (η) for tube with inserting helical tape was 1.4 for water only, and 1.8 for nanofluid at concentration 0.8%. Comparison with the previous work gave good agreement.

Key words: Nanofluid, Horizontal tube, Convection heat transfer, Helical tape insert.

1. INTRODUCTION

The conventional fluids, such as water, engine oil and ethylene glycol are normally used as heat transfer fluids. Although various techniques are applied to enhance the heat transfer, the low heat transfer performance of these conventional fluids obstructs the performance enhancement and the compactness of heat exchangers. The use of solid particles as an additive suspended into the base fluid is a technique for the heat transfer enhancement. Improving of the thermal conductivity is the key idea to improve the heat transfer characteristics of conventional fluids. Since a solid metal has a larger thermal conductivity than the base fluid, suspending metallic solid fine particles into the base fluid is expected to improve the thermal conductivity of that fluid. The long time stability and large efficient thermal conductivity; the innovative heat transfer fluids-suspended by nanometer-sized solid particles (its size below 100 nm) are called 'nanofluids'. These suspended nano-particles can change the transport and thermal properties of the base fluid. Nanofluids are suspensions of metallic or nonmetallic nano-powders in base liquid and can be employed to increase heat transfer rate in various applications.

Swirl flow devices form an important group of passive augmentation methods. Tubes fitted with helical screw-tape inserts is one of the most important members of this group. These tubes are the most widely used in several heat transfer applications; for example, heat recovery processes, air conditioning and refrigeration systems, and chemical reactors.

Mirmasoumi and Behzadmehr, (2008) studied numerically the fully developed mixed convection of a nanofluid (water/ Al_2O_3). Two-phase mixture model has been used to investigate the effects of nano-particles mean diameter on the flow parameters. The calculated results demonstrate that the convection heat transfer coefficient significantly increases with decreasing the nano-particles mean diameter. Using particles with smaller diameter increases the uniformity of the particles distribution at the tube cross section. While, increasing nano-particles mean diameter and/or Grashof numbers could result non-uniform distribution for which the single phase approach no longer would be precise.

Sivashanmugam and Suresh, (2007 a&b) studied experimentally the heat transfer and friction factor characteristics of circular tube fitted with full-length helical screw element of different twist ratio, and full length with different spacer length have been studied with uniform heat flux under laminar and turbulent flow conditions. The experimental data obtained were compared with those obtained from plain tube published data. The heat transfer coefficient and friction factor increased with the twist ratio. Empirical correlations were formed for explaining data and found to fit experimental data.

Heris et al., (2007) studied experimentally forced convection heat transfer of Al_2O_3 /water nanofluid inside a circular tube with constant wall temperature. Heat transfer coefficient increases by increasing the concentration of nano-particles in nanofluid. The increase in heat transfer coefficient due to presence of nano-particles is much higher than the prediction of single phase heat transfer correlation

used with nanofluid properties. It is concluded that thermal conductivity increase is not the sole reason for heat transfer enhancement in nanofluids. Other factors such as dispersion and chaotic movement of nanoparticles, and particle migration may play role in heat transfer augmentation due to nano-particles. Particle fluctuations and interactions, especially in high Peclet number may cause the change in flow structure and lead to augmented heat transfer due to the presence of nano-particles.

Naphon (2006) presented new heat transfer data of the inner tube, of a double pipe, with twisted tape insert. Effects of relevant parameter on the heat transfer and pressure drop are considered. The inner and outer diameters of the inner tube are 8.1 and 9.54 mm, respectively. The twisted tape is made from the aluminum strip with thickness of 1 mm and the length of 2000 mm. The twisted tape insert has significant effect on enhancing heat transfer rate. However, the pressure drop also increases. Moreover, the new proposed correlations for the Nusselt number and friction factor based on the experimental data were obtained.

Naphon and Sriromrulin (2006) studied the heat transfer characteristics and the pressure drop of the micro-fin tube coiled wire insert. The coiled wire insert has a significant effect on the enhancement of heat transfer. However, the friction factor of the tube with the coiled wire insert also increases.

Eiamsa-ard et al. (2006), studied experimentally, heat transfer and friction characteristics in a circular tube fitted with full-length twisted tapes and regularly spaced twisted tapes. It can be found that enhancing heat transfer with passive method using different types of twisted tape construction in the inner tube of a double pipe heat exchanger can improve the heat transfer rate efficiently. However, the friction factor of the tube with the twisted tape insert also increases. The increase in heat transfer and friction can be

explained by the swirling flow as a result of the secondary flows of the fluid.

Ding and Wen (2005) illustrated that the nano-particles migration due to spatial gradient in viscosity and shear rate has a significant implication to heat transfer. The aim of this work is to study laminar flow convective heat transfer of Al_2O_3 /water nanofluid under constant wall temperature and different concentrations of nano-particles.

Maiga et al. (2005), investigated, by numerical simulation, the hydrodynamic and thermal characteristics of a laminar forced convection flow of nanofluids inside a straight heated tube and a radial space between coaxial and heated disks. Two particular nanofluids were considered, namely Ethylene Glycol- Al_2O_3 and water- Al_2O_3 . Results have clearly revealed that the addition of nano-particles has produced a remarkable increase of the heat transfer with respect to that of the base liquids. It has been found that the Ethylene Glycol- Al_2O_3 mixture yields, so far, a better heat transfer enhancement than water- Al_2O_3 . For the case of the tube flow in particular, results have also shown that, in general, the heat transfer enhancement due to nano-particles clearly becomes more pronounced with an augmentation of the flow Reynolds number. Correlations have been provided for computing the Nusselt number for the nanofluids considered in terms of the Reynolds and the Prandtl numbers and this for both the thermal boundary conditions considered.

Maiga et al. (2004) studied, numerically, the forced convection flow of water/ Al_2O_3 and ethylene glycol/ Al_2O_3 nanofluids inside a uniformly heated tube that is submitted to a constant and uniform heat flux at the wall. It is observed that the inclusion of nano-particles has increased considerably the heat transfer at the tube wall for both the laminar and turbulent regimes. Such improvement of heat transfer becomes more pronounced with the increase of the particle concentration.

On the other hand, the presence of particles has produced adverse effects on the wall friction that also increases with the particle volume concentration. Results have also shown that the ethylene glycol/ Al_2O_3 mixture gives a far better heat transfer enhancement than the water/ Al_2O_3 mixture.

Wen and Ding (2004) have studied Al_2O_3 /water nanofluid heat transfer in laminar flow under constant wall heat flux and reported an increase in nanofluid heat transfer coefficient with Reynolds number and nano-particles concentration particularly at the entrance region. They expressed that thermal developing length for nanofluid was greater than pure water. The reason for heat transfer enhancement for nanofluids is the decreased thermal boundary layer thickness due to non-uniform distribution of thermal conductivity and viscosity resulting from motion of nano-particles.

The aim of the present work is to study laminar flow convective heat transfer and friction factor of Al_2O_3 /water nanofluid under constant wall heat flux and different concentrations of nano-particles with and without helical tape insert at different values of nanofluid mass flow rates and heat fluxes.

2. EXPERIMENTAL TEST LOOP

An experimental test loop has been designed and built to study the effect of different operating parameters on the convective heat transfer and friction factor for the working fluids (nanofluid with different concentrations and water only). The operating parameters are heat flux, concentration and mass flow rate of nanofluid or water only, which flows inside a horizontal tube with and without inserting helical tape. A schematic diagram for the experimental test loop is shown in Fig. (1). It consists of nanofluid cooling circuit, the tested tube and its heating unit.

The circulating pump is used to circulate nanofluid (Al_2O_3 /water) through

the test loop. The specified amount of nanofluid is controlled to flow inside the tested tube and the remaining amount passed to the tank. Paddle wheel is used to stir constantly the nanofluid inside the tank during the experiments to prevent deposition of the nanoparticles. The concentration of nanofluid is varied from 0 to 2% by volume. Nanofluid is heated in the tested tube to study the convection heat transfer and friction pressure drop at different operating parameters. The nanofluid is cooled when leaving the tested tube in the heat exchanger. City water is used in the heat exchanger to cool the nanofluid to the initial temperature for nanofluid inside the tank. Then the nanofluid returned back to the tank to complete the cycle. Mass flow rate is varied and the corresponding values of Reynolds number ranging from 600 to 2500.

The tested tube is made from copper and the inner diameter is of 25 mm and it is of length 1000 mm with thickness 1.5 mm. Uniform heat flux condition is achieved by heating the outer wall of the tested tube by an electric heater coil wrapped around it. A thin layer of electric insulation (Mica sheet) is found between the electric coil and the tested tube. The supplied power to the heating coil is changed by using step less variable output power supply (Variac). Through out all experiments, the resistance of heating coil has constant value of 30 Ω .

The geometrical configuration of helical screw tape inserts is shown in Fig. (2). The helical screw tape inserts with specified twist ratio (equal to 4) is made by winding uniformly a strip of 2 mm width and 2 mm thickness over a 5 mm rod with pitch 20 mm, and coated with chromium by electroplating to prevent corrosion. The twist ratio defined as the ratio of length of one full twist (360 degree) to diameter. The value of the twist ratio reported in literature between 2 and 7 for twisted tape inserts [2]. It is inserted inside the tested tube at the center as shown in Fig. (2.a).

To ensure minimum heat loss to the surroundings, a layer of 50-mm of glass wool thermal insulation followed by additional aluminum foil sheet is wrapped on the outer surface of the tested tube.

3. EXPERIMENTAL PROCEDURE

Before starting a new run, the test loop is checked for leakage of working fluid nanofluid (Al_2O_3 /water). The experimental procedure for each run can be described in the following steps:

- 1) Switch on the pump motor to circulate nanofluid. Air is extracted from the U-tube manometer through a vent valve.
- 2) Adjust the discharge valve to obtain the desired flow rate for circulating nanofluid. The circulating nanofluid is then heated up through the tested tube by the heating coil.
- 3) The hot nanofluid is passed through the heat exchanger to remove the heat absorbed by the nanofluid in the tested tube using cooling city water.
- 4) Before recording any data, each experiment is carried out for about 30 minutes to insure steady state condition was reached (the fluctuation in temperatures was about ± 0.1 °C).
- 5) The required measurements are recorded for each experiment.
- 6) Repeat the run for different values of the operating parameters.

4. EXPERIMENTAL MEASUREMENTS

To compute the total input heat the applied volt to the electrical coil was measured by voltmeter with minimum readable value ± 0.1 volt.

Also the temperatures were measured by temperature recorder with accuracy ± 0.1 °C. Two thermocouples of K-type are used to measure inlet and outlet nanofluid temperatures. Outer surface temperatures for the tested tube are measured along its length at the following locations; 0, 150 mm, 350 mm, 550 mm, 750 mm and 950 mm. Also inlet and outlet temperatures for the city water which flows inside the heat exchanger are measured to control the cooling process for nanofluid. Also,

ambient and insulation temperatures were measured.

The nanofluid flow rate was measured by using flow meter. Also, cooling city water which flows in heat exchanger to cool the nanofluid was measured by flow meter. The accuracy of the used flow meters was 2% of the full scale.

The pressure drop for nanofluid flows through the tested tube was measured by using U-tube mercury manometer.

The experimental apparatus was allowed to operate until the fluctuation in temperatures was about ± 0.1 °C. Then, steady state condition was reached and the required measurements of the applied volt, temperature, flow rate, and pressure drop were taken. The root-mean-square random error propagation analysis was carried out in the standard fashion using the measured experimental uncertainties of the basic independent parameters. The error analysis is done for the average values of the calculating parameters. The experimental uncertainties associated with these measurement techniques were estimated to be approximately equal to 4.5% and 5.6% for convection heat transfer coefficient and friction factor respectively.

5. DATA REDUCTION

The basic measurements were analyzed using a computer reduction program to calculate the friction factor and convection heat transfer coefficient for nanofluid flow inside the tested tubes.

5.1 Pressure drop

The measured pressure drop includes frictional, entrance and exit components. The entrance and exit components were small and may be neglected. Therefore, the measured pressure drop (ΔP) for nanofluid flow inside the tested tube is then directly related to the frictional pressure drop. The friction factor (f) was obtained from the pressure drop measurements through the tested tube as;

$$f = \frac{2(\Delta P)d}{\rho_{nf} U^2 L} \quad (1)$$

Where d , L , U and ρ_{nf} are the tested tube inner diameter and length, mean velocity and density for nanofluid.

The mean velocity can be calculated by dividing the measured volume flow rate by cross sectional area of the tested tube without inserts. If the blockage due to helical tape insert was considered it is calculated as follow;

Before assembly the test loop, the volume of water filling the tested tube with and without helical tape insert can be measured experimentally. Then, the corresponding cross section area with blockage was obtained. The mean velocity can be calculated by dividing the measured volume flow rate by this obtained area.

5.2 Heat transfer

At steady state, the total input heat from the electric heater coil wrapped around the tested tube (Q_i) divided into useful heat which flows through the tube wall to nanofluid (Q_{us}) and the remaining amount of heat transferred to the surrounding as heat loss (Q_{loss}).

The total input heat can be determined as;

$$Q_i = (V^2 \cos \varphi) / R \quad (2)$$

Where: V , $\cos \varphi$ and R are the applied voltage across electric heater, power factor and electric resistance of electric heater respectively.

The useful heat transfer to the nanofluid can be calculated as;

$$Q_{us} = m_{nf} C_{p,nf} (T_{nf,o} - T_{nf,i}) \quad (3)$$

Where; m_{nf} , $C_{p,nf}$, $T_{nf,i}$ and $T_{nf,o}$ are mass flow rate, specific heat, inlet and outlet temperatures of nanofluid respectively.

The amount of heat loss from outer surface of insulation to the surrounding air (Q_{loss}) can be determined as;

$$Q_{loss} = Q_i - Q_{us} \quad (4)$$

Heat flux (q'') can be calculated from the following equation as;

$$q'' = Q_{us} / A \quad (5)$$

Where; A = Inside surface area for tested tube ($A = \pi dL$). Also, d is the inner diameter of the tested tube and L is the tested tube length.

To calculate the local average temperature along the tested tube, one can divid the tube into set of elements and carry out the heat balance for each element. The outlet temperature at each element, see in figure (2-b), can be determined using the following relation;

$$T_{i+1} = T_i + \frac{Q_{us}}{m_{nf} C_{p,nf}} \Delta z / L \quad (6)$$

Where; Δz , T_i and T_{i+1} are element length, inlet and outlet temperatures for each element. The bulk temperature of nanofluid within each element is estimated by the following relation;

$$T_b = \frac{T_{i+1} + T_i}{2} \quad (7)$$

The local heat transfer coefficient can be calculated with the aid of the measured local wall temperatures and the above calculated bulk temperature as;

$$h = \frac{q'' (\Delta z / L)}{(T_w - T_b)} \quad (8)$$

Where; T_w is the local wall temperature along the tested tube.

The average heat transfer coefficient can be calculated as;

$$h_{av} = \frac{1}{L} \int_0^L h dz \quad (9)$$

Based on the inner diameter of the tested tube, Local Nusselt number, average Nusselt number, and Reynolds number are evaluated using the following relations;

$$Nu = \frac{h d}{k_{nf}} \quad , \quad Nu_{av} = \frac{h_{av} d}{k_{nf}} \quad (10)$$

$$Re = \frac{4 m}{\pi d \mu_{nf}} \quad (11)$$

Where k_{nf} , μ_{nf} and m_{nf} are the thermal conductivity, dynamic viscosity, and mass flow rate of nanofluid.

Thermal-hydraulic performance (η) is defined by Chang et al. (2007) as follow;

$$\eta = (Nu/Nu_w) (f/f_w)^{0.33} \quad (12)$$

One can assume that the nanoparticles are well dispersed within the base-fluid, so the effective physical properties are described by classical formulas which mentioned by Mansour et al. (2007) as;

$$\rho_{nf} = (1 - \Phi) \rho_f + \Phi \rho_p \quad (13)$$

$$\rho_{nf} C_{p,nf} = (1 - \Phi) \rho_f C_{p,f} + \Phi \rho_p C_{p,p} \quad (14)$$

Where, Φ is the nano-particle volume fraction.

The effective dynamic viscosity of nanofluids can be calculated using different existing formulas that have been obtained for two-phase mixtures. The following relation is the well-known Einstein's equation for a viscous fluid containing a dilute suspension of small, rigid, spherical particles[2].

$$\begin{aligned} \mu_{nf} &= \mu_f (1 + 2.5 \Phi) \\ k_w &= k_f (1 + 7.4 \times \Phi) \end{aligned} \quad (15)$$

The relevant thermo-physical properties of the solid nanoparticles (Al_2O_3) used in the present study are specified as;

$C_{p,p} = 773 \text{ J/kg} \cdot ^\circ\text{C}$, $\rho_p = 3880 \text{ kg/m}^3$, and $k_p = 36 \text{ W/m} \cdot ^\circ\text{C}$.

6. RESULTS AND DISCUSSIONS

Experimental runs are performed to study the effects of heat flux, Reynolds number for nanofluid (with different concentrations, ϕ) flow inside tube with inserting helical tape compared with plain tube on heat transfer and friction factor.

6.1 Friction factor

Pressure drop experiments were performed for adiabatic condition to obtain the friction factor for nanofluid and water only flow inside tube with inserting helical tape compared with plain tube. Figure (3) shows the variation of friction factor (f) versus Reynolds number (Re) for both tubes. It is observed from figure that, friction factor decreases with increasing Reynolds number for pure water flow inside both tubes. Also, it is clear from figure that, friction factor in tube with inserting helical tape has higher values than that for the plain tube. The increase in the friction can be explained by the swirling flow as a result of the secondary flows of the fluid. This hydraulic behavior for tube with inserting helical tape was expected because it promotes more friction. Comparison between the values of friction factor for nanofluid with concentration=0.6 % and pure water flow inside tube with inserting helical tape is shown also in Fig. (3). It is clear from figure that, friction factor for nanofluid was higher than that for water only. Nano-particles suspended in the base fluid of nanofluid changes the transport properties than the base fluid and causes an increase for friction factor compared with water only.

6.2 Heat transfer

Local surface temperatures along the tested tube was measured at five locations

and plotted in figures (4-6) for tube with inserting helical tape and plain tube. Local surface temperatures along the plain tube were presented in Fig. (4) for different values of heat flux and certain value of Reynolds number ($Re=1200$). It is observed that surface temperature increases along tube length and increases with increasing heat flux. Local surface temperatures along the tested tube with inserting helical tape takes lower values than plain tube as shown in Fig. (5). This decrease in the surface temperature for tube with inserting helical tape can be explained by the swirling flow as a result of the secondary flows of the fluid.

Local surface temperatures along the tested tube with inserting helical tape and nanofluid at concentration=0.8% flows inside it was presented in Fig. (6). It takes lower values when compared with the same tube but water only flows inside it.

Local convection heat transfer coefficient along the tested tube was calculated at five locations and plotted in figures (7-9) for tube with inserting helical tape and plain tube. The increase in convection heat transfer coefficient for tube with inserting helical tape compared with plain tube can be explained by the swirling flow as a result of the secondary flows of the fluid.

Nano-particles leads to increase thermal conductivity for nanofluid, therefore convection heat transfer coefficient increases. Also, other factors such as dispersion and chaotic movement of nanoparticles, and particle migration, particle fluctuations and interactions may play role in heat transfer augmentation.

Figure (10) shows the variation of the average heat transfer coefficient versus Reynolds number. It is observed from figure that, average heat transfer coefficient increases with increasing Reynolds number and take the higher values for nanofluid compared with water only.

Figure (11) shows the variation of the average Nusselt number versus Reynolds number. It is clear from figure that, average

Nusselt number takes the same behaviour like average convection heat transfer coefficient and increases with increasing Reynolds number and the higher values were obtained for nanofluid compared with water only.

Figure (12) shows the variation of the average Nusselt number versus nanofluid concentrations. Average Nusselt number increases with increasing the concentration of nano-particles in nanofluid and take the highest value at 0.8%, then it decreases with increasing concentration.

In the present study the thermal-hydraulic performance (η) of the fabricated helical tape insert, was estimated for nanofluid flow inside it and compared with water only. The thermal hydraulic performance is defined using the Nusselt numbers and friction factors for a plain tube and a tube fitted with an insert as follows; $\eta = (Nu/Nu_{PL}) / (f/f_{PL})^{0.33}$. The calculated thermal hydraulic performances versus Reynolds number, for different setups are compared in Fig. (13). The figure shows that the highest values were obtained for nanofluid compared with water. The average value for the thermal hydraulic performance was 1.4 and 1.8 for water only and nanofluid at concentration 0.8% respectively.

The present experimental values of the obtained average heat transfer coefficient versus Reynolds number for 0.6% and 0.8% concentrations are presented and compared with the previous work by Maiga et al. (2005) at 0.7% concentration, as shown in Fig. (14). It is observed that, there is a good agreement between the present experimental results and previous results.

CONCLUSIONS

Forced convection heat transfer and friction factor for nanofluid flows inside circular horizontal tube with and without inserting helical tape, was studied experimentally. Experiments are conducted with adding nano-particles (Al_2O_3) to water up to 2% by volume to study the effect of nanofluid concentration.

The obtained experimental results show that convection heat transfer coefficient and friction factor for tube with inserting helical tape take higher values compared with plain tube. This increase can be explained by the swirling flow as a result of the secondary flows of the fluid. Thermal hydraulic performance for tube with inserting helical tape was 1.4 when using water only, and 1.8 when using nanofluid at concentration 0.8%.

Appendix

Nanofluid preparation

Preparation of nanoparticles suspension is the first step in applying nanofluid for heat transfer enhancement. In the present study Al_2O_3 /water nanofluid was employed. Al_2O_3 nanoparticles with an average diameter of 20 nm were dispersed in water. In our study no dispersant or stabilizer was used. This is because of the fact that addition of any agent may change the fluid properties. The nanofluids with six different Al_2O_3 nanoparticle concentrations (0.2%, 0.4%, 0.6%, 0.8%, 1.0%, 1.5% and 2.0% volume fraction) were prepared and used to study enhanced heat transfer. The volume fraction and the density of the nanoparticles in suspension are defined as follows:

$$\Phi = \frac{V_p}{V_f}$$

$$\rho_p = \frac{m_p}{V_p}$$

Then the required mass of nanoparticles for 1 liter in nanofluid suspension determined as follows:

$$m_p = 1 \times 10^{-3} \times \Phi \times \rho_p$$

After preparing required volume of the powder, using the equivalent weight of the solid, nanoparticles were mixed with distilled water in a flask and then vibrated for 8–16 h in mixer system. No

sedimentation was observed for (0.2 to 2.0% volume) suspension after 24h.

REFERENCES

- [1] Mirmasoumi, S. and Behzadmehr, A., 2008 "Effect of nanoparticles mean diameter on mixed convection heat transfer of a nanofluid in a horizontal tube" *International Journal of Heat and Fluid Flow* Vol. 29, pp. 557–566.
- [2] Sivashanmugam, P., and Suresh, S., 2007-a "Experimental studies on heat transfer and friction factor characteristics of turbulent flow through a circular tube fitted with regularly spaced helical screw-tape inserts" *Applied Thermal Engineering* Vol. 27, pp. 1311–1319.
- [3] Sivashanmugam, P., and Suresh, S., 2007-b "Experimental studies on heat transfer and friction factor characteristics of laminar flow through a circular tube fitted with regularly spaced helical screw-tape inserts" *Experimental Thermal and Fluid Science* Vol. 31, pp. 301–308.
- [4] Heris, S.Z., Esfahany, M.N. and Etemad, S.G., 2007 "Experimental investigation of convective heat transfer of Al_2O_3 /water nanofluid in circular tube" *International Journal of Heat and Fluid Flow*, vol. 28, pp. 203–210.
- [5] Mansour, R.B., Galanis, N., and Nguyen, C.T., 2007 "Effect of uncertainties in physical properties on forced convection heat transfer with nanofluids." *Applied Thermal Engineering* Vol. 27, pp. 240–249.
- [6] Chang, S.W., Yang, T.L. and Liou, J.S. 2007 "Heat transfer and pressure drop in tube with broken twisted tape insert" *Experimental Thermal and Fluid Science* Vol. 32 pp. 489–501.
- [7] Naphon, P., 2006 "Heat transfer and pressure drop in horizontal double pipes with and without twisted tape insert" *Int. Communications in Heat*

- and Mass Transfer, Vol. 33, pp. 166–175.
- [8] Naphon, P., and Sriromrual, P., 2006 "Single-phase heat transfer and pressure drop in the micro-fin tubes with coiled wire insert" *International Communications in Heat and Mass Transfer*, Vol. 33, pp. 176–183.
- [9] Eiamsa-ard, S., Thianpong, T., and Promvonge, P., 2006 "Experimental investigation of heat transfer and flow friction in a circular tube fitted with regularly spaced twisted tape elements" *Int. Communications in Heat and Mass Transfer*, Vol. 33, pp. 1225–1233.
- [10] Ding, Y., Wen, D., 2005 "Particle migration in a flow of nanoparticle suspensions," *Powder Technology* 149 (2), 84–92.
- [11] Maiga, S.E., Palm, S.J., Nguyen, C.T., Roy, G, and Galanis, N., 2005 "Heat transfer enhancement by using nanofluids in forced convection flows" *International Journal of Heat and Fluid Flow*, Vol. 26, pp. 530–546.
- [12] Maiga, S.E., Nguyen, C.T., Galanis, N. and Roy, G, 2004 "Heat transfer behaviours of nanofluids in a uniformly heated tube" *Superlattices and Microstructures*, Vol. 35, pp. 543–557.
- [13] Wen, D., and Ding, Y., 2004 "Experimental investigation into convective heat transfer of nanofluid at the entrance region under laminar flow conditions," *International Journal of Heat and Mass Transfer* 47 (24), 5181–5188.
- m : Mass flow rate, kg/s
 Nu : Nusselt number, -
 Q : Heat transfer rate, W
 q" : Heat flux, W/m²
 r : Radial direction, m
 R : Electric resistance, Ω
 Re : Reynolds number, -
 T : Temperature, °C
 U : Mean velocity of nanofluid, m/s
 V : Heater voltage, V
 Z : Axial direction, m
 Cosφ : Power factor, -
 ΔP : Pressure drop, Pa
 Φ : Nano-particle volume fraction, -
 ρ : Density, kg/m³
 μ : Dynamic viscosity, kg/m.s
 η : Thermal hydraulic performance, -

Subscripts:

- av : average
 b : bulk
 i : input
 loss : loss
 L : base liquid (water)
 nf : nanofluid
 o : output
 p : nano-particle
 PL : plain
 t : total
 us : useful
 w : wall

NOMENCLATURE

- A : Surface area, m²
 Cp : Specific heat, J/kg. °C
 d : Inner diameter of the tested tube, m
 f : Friction factor
 h : Heat transfer coefficient, W/m². °C
 k : Thermal conductivity, W/m. °C
 L : Length of the tested tube, m

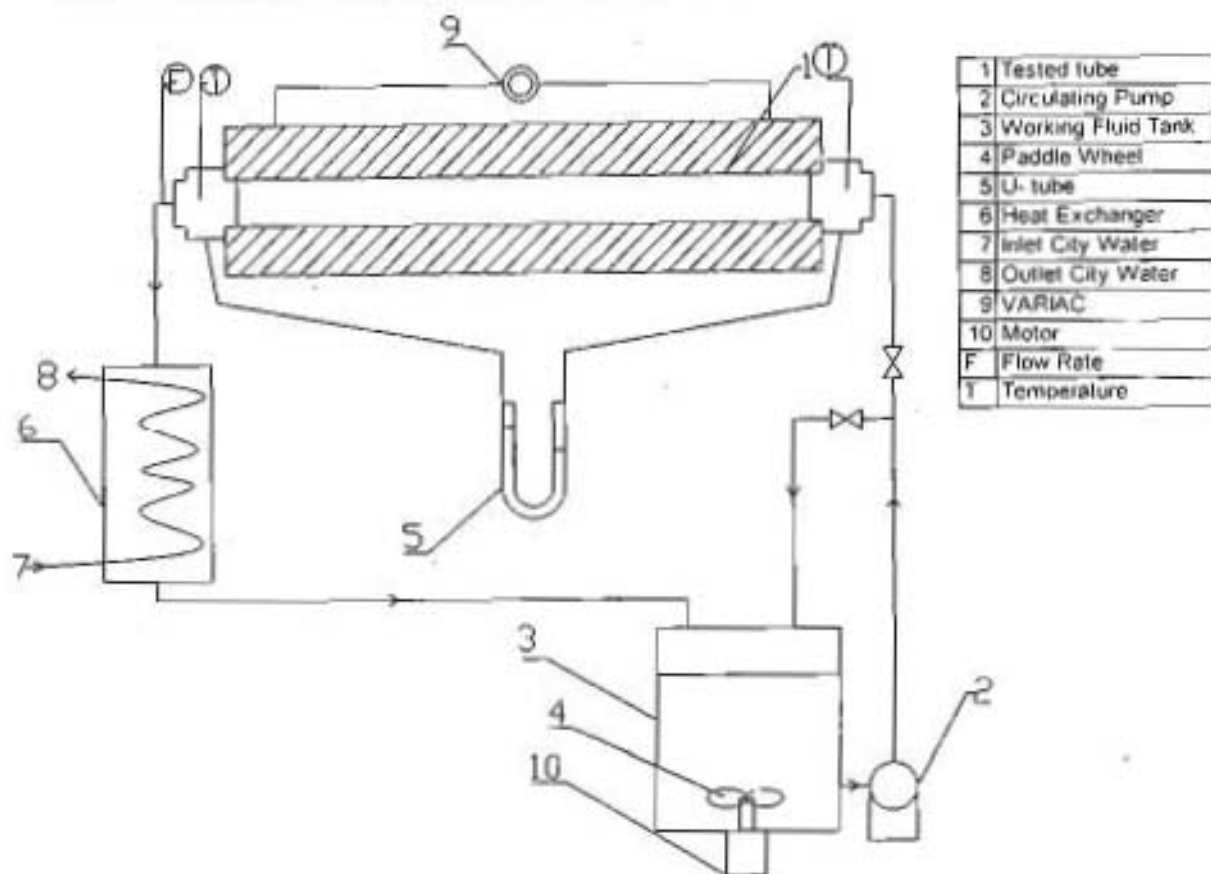

1	Tested tube
2	Circulating Pump
3	Working Fluid Tank
4	Paddle Wheel
5	U- tube
6	Heat Exchanger
7	inlet City Water
8	Outlet City Water
9	VARIAC
10	Motor
F	Flow Rate
T	Temperature

Fig (1) Experimental test loop

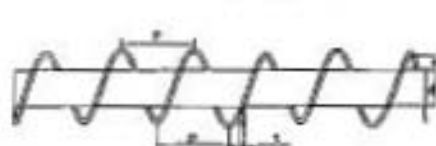

Fig(2.a) Helical Tape Insert with rod
 d defiled diameter P Pitch t tape thickness w tape width

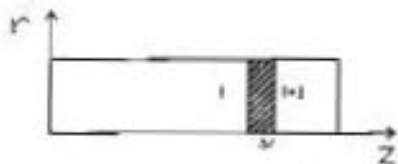

Fig(2.b) Element of Tube

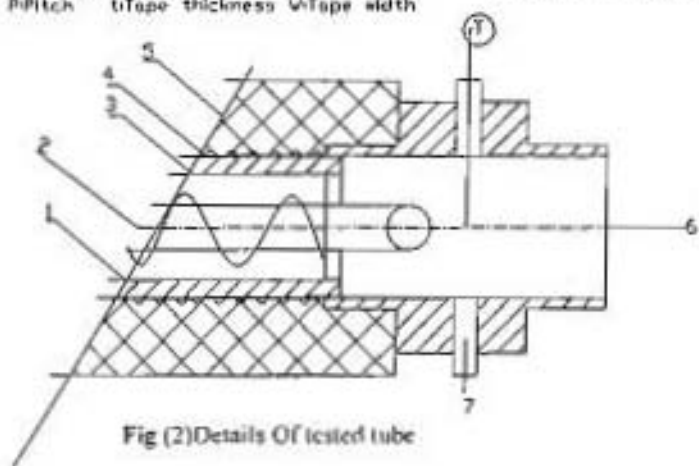

1	Tested Tube
2	Helical Tape Insert
3	Mica Sheet
4	Electric Heater Coil
5	Insulation
6	Inlet Working Fluid
7	To Manometer
T	Temperature

Fig (2) Details Of tested tube

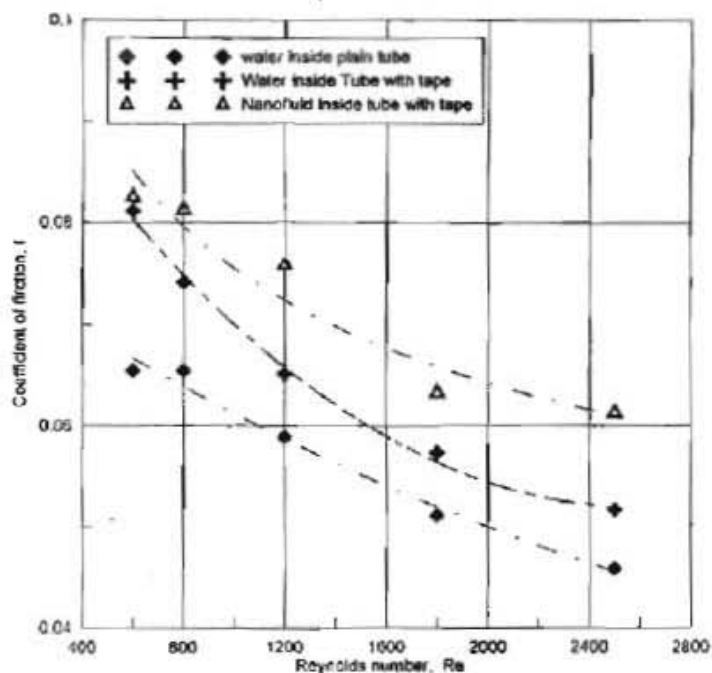

Fig. (3) Friction factor versus Reynolds number for nanofluid (concentration=0.6%) and water flow inside tube with inserting helical tape and plain tube.

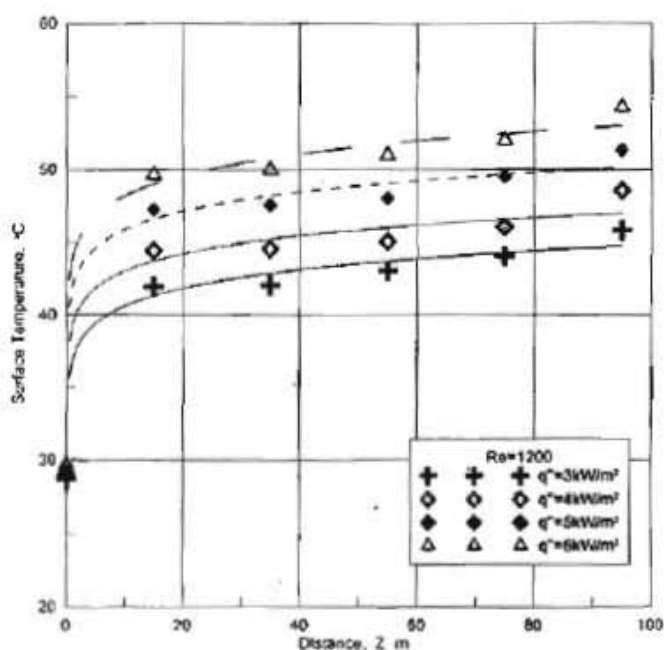

Fig. (4) Local surface temperature along plain tube tested on water only for different values of heat flux.

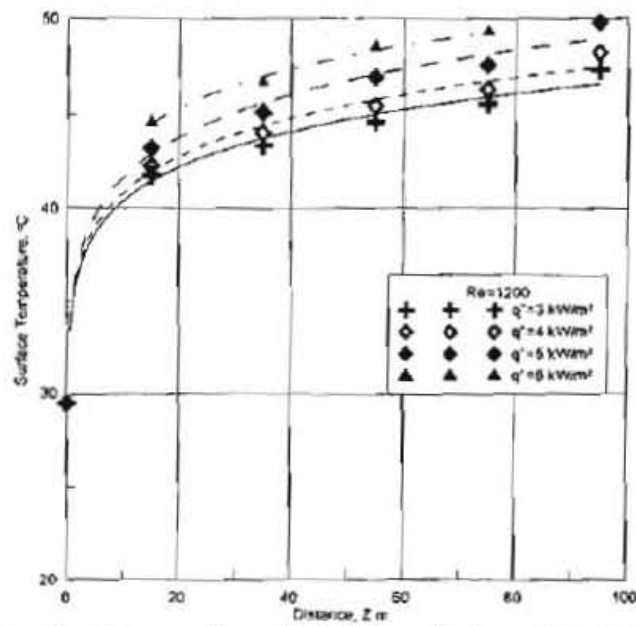

Fig. (5) Local surface temperature along tube with inserting helical tape tested on water only for different values of heat flux.

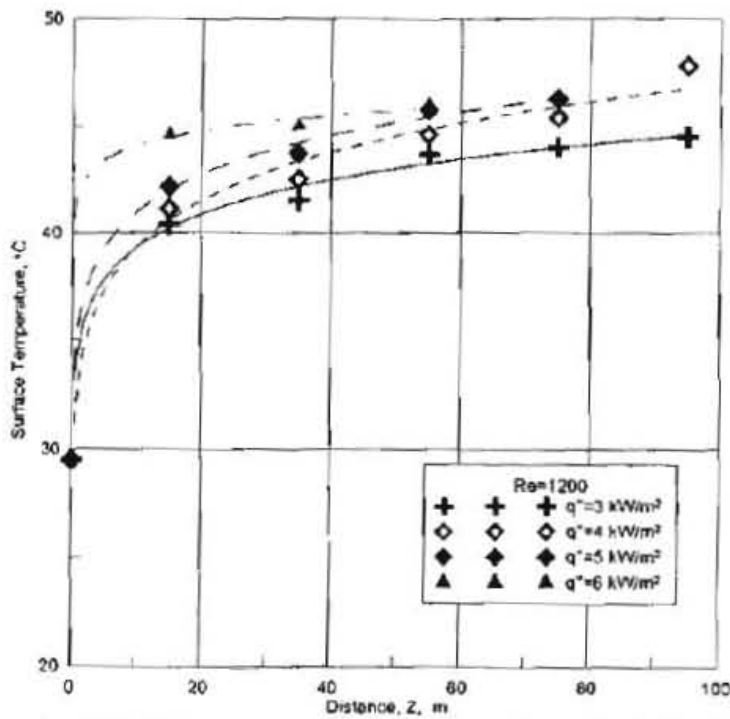

Fig. (6) Local surface temperature along tube with inserting helical tape tested on nanofluid (concentration=0.8 %) for different values of heat flux.

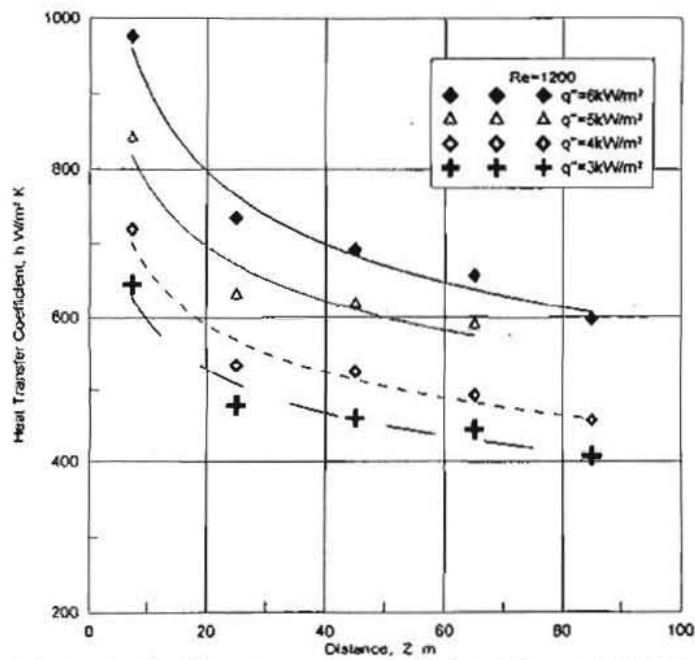

Fig. (7) Local convection heat transfer coefficient along plain tube tested on water only for different values of heat flux.

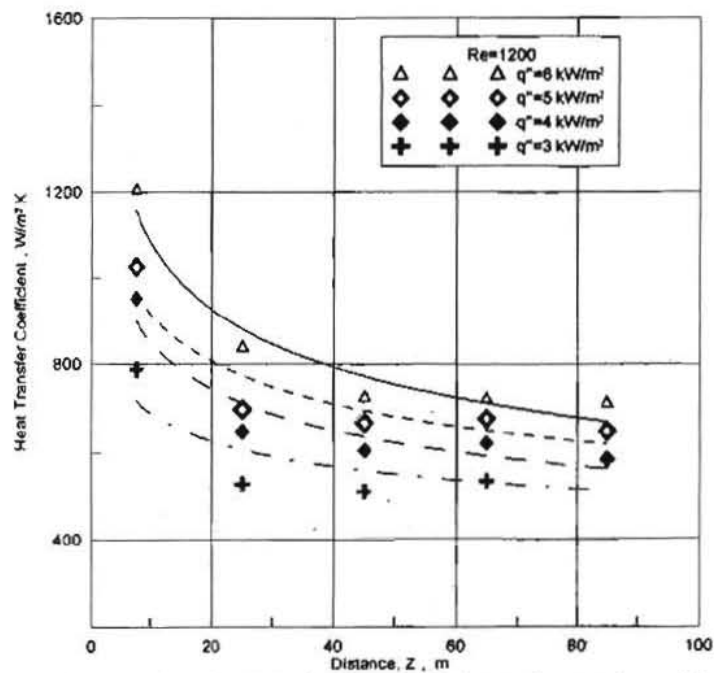

Fig. (8) Local convection heat transfer coefficient along tube with inserting helical tape tested on water only for different values of heat flux.

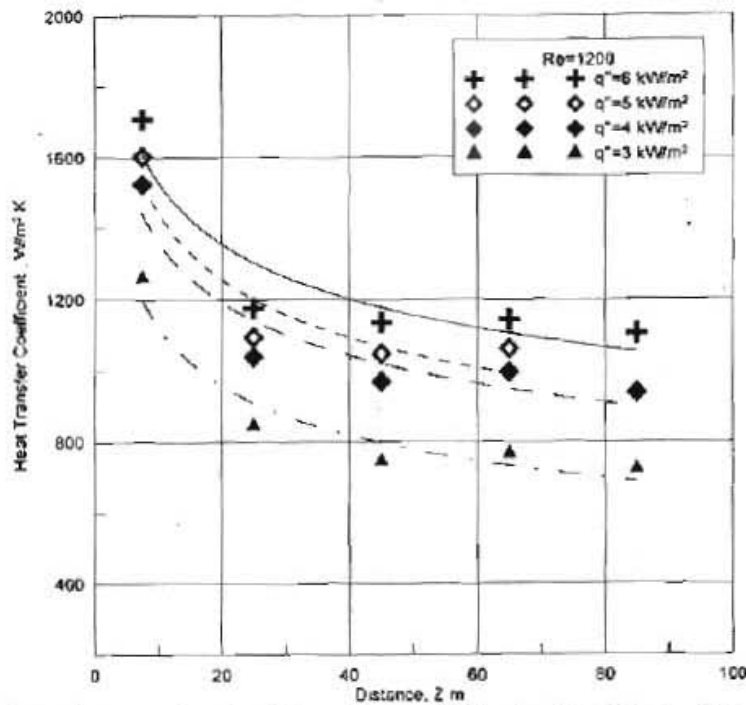

Fig. (9) Local convection heat transfer coefficient along tube with inserting helical tape tested on nanofluid (concentration=0.8 %) for different values of heat flux.

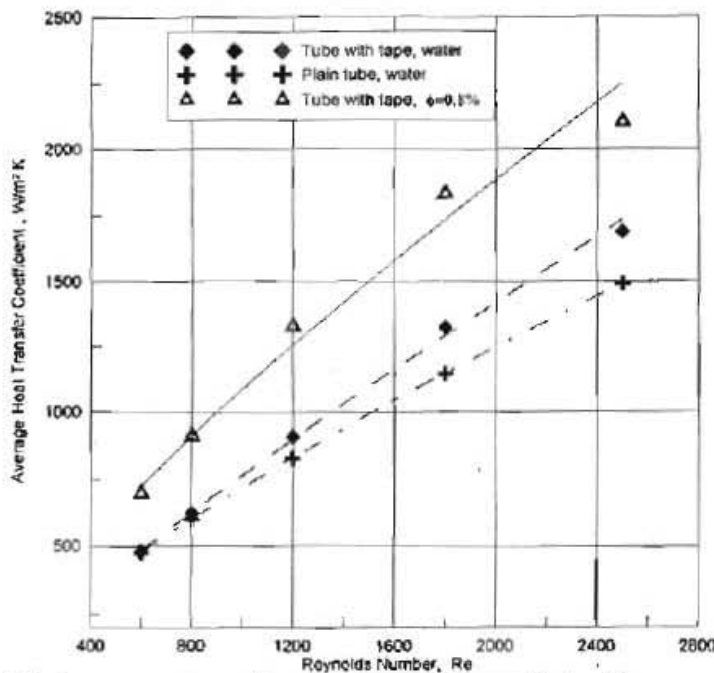

Fig. (10) Average convection heat transfer coefficient for nanofluid (concentration= 0.8 %) and water only flow inside tube with inserting helical tape compared with plain tube.

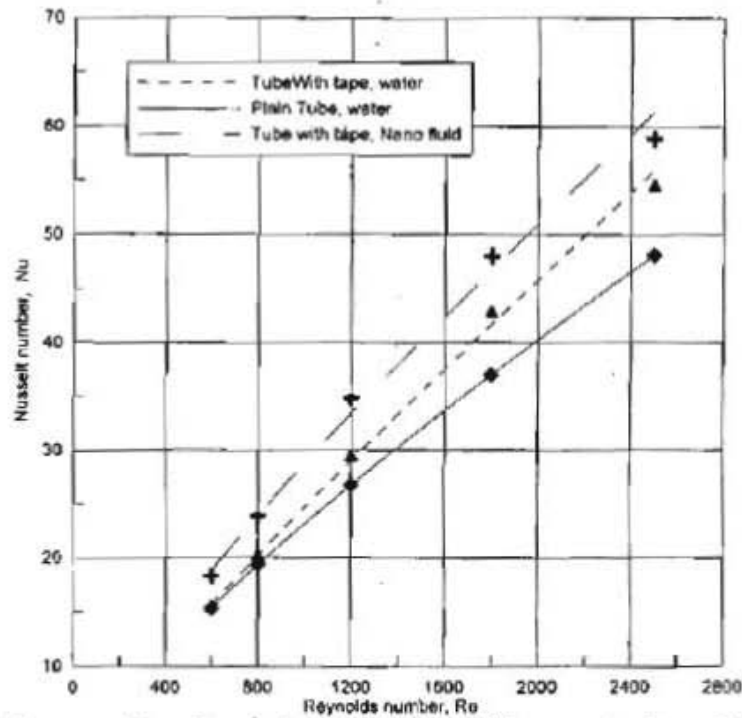

Fig. (11) Average Nusselt number for nanofluid (concentration= 0.8 %) and water-only flow inside tube with inserting helical tape compared with plain tube.

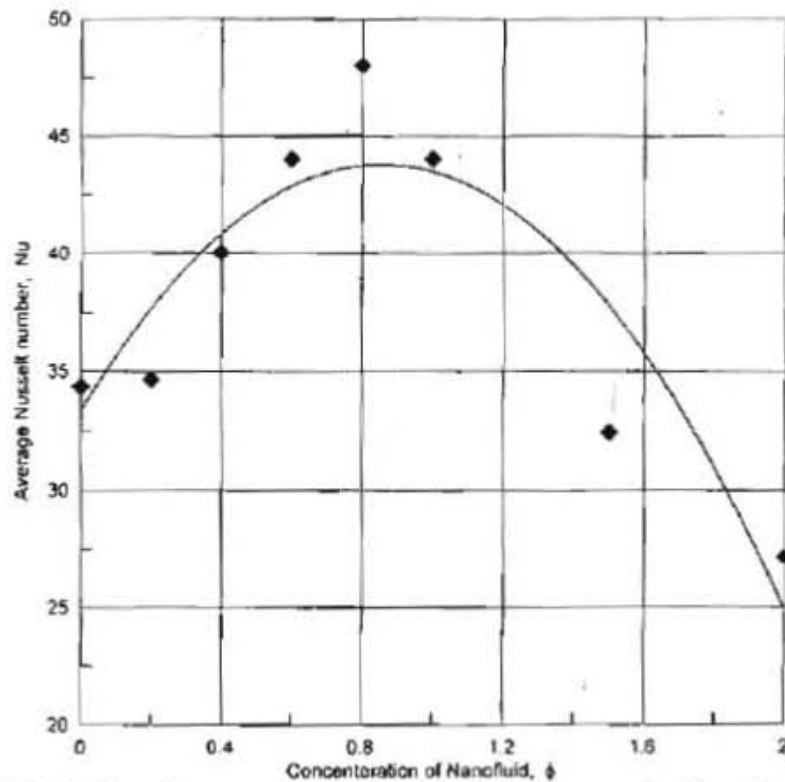

Fig. (12) Variation of average Nusselt number with concentration of nanofluid flows inside tube with inserting helical tape (at $Re=1800$).

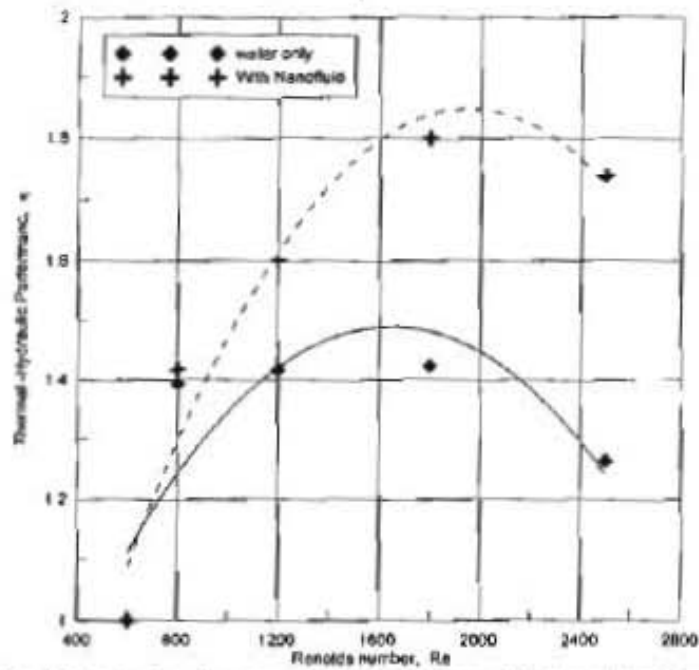

Fig. (13) Coefficient of enhancement versus Reynolds number for nanofluid (concentration=0.8%) and water flow inside tube with inserting helical tape.

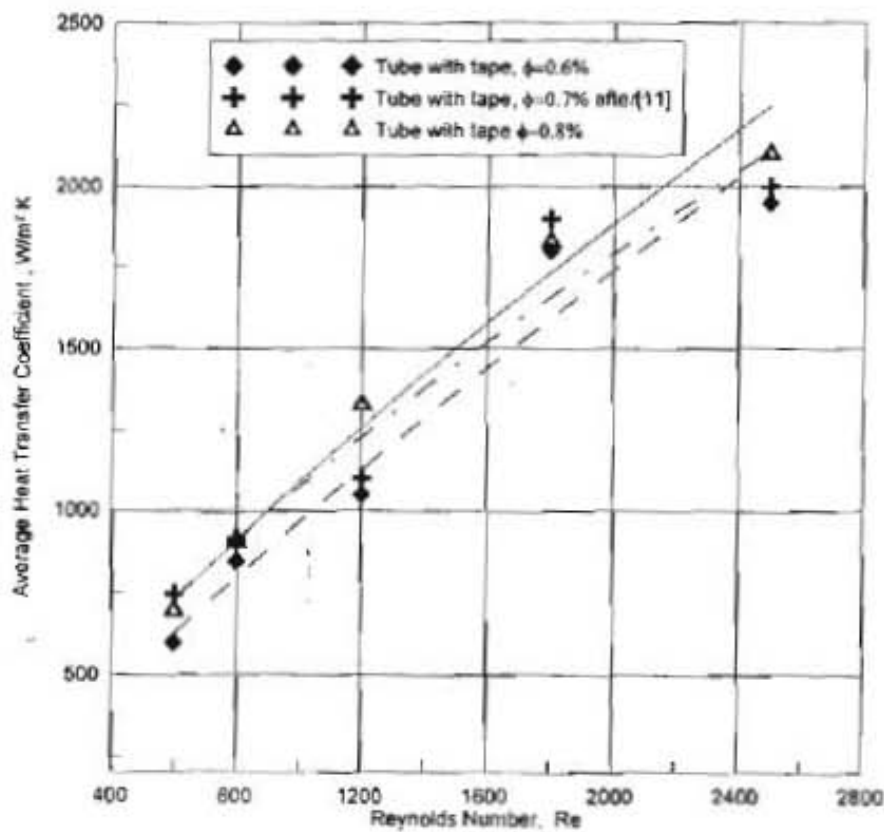

Fig. (14) Comparison with the previous work.